

GM

INSTRUMENTS

Osicus Audiometer

User Guide

Issue 12

**UK
CA**

0086

Contents

1. Osicus Audiometer Important Safety Information	5
2. Technical Specification	8
3. Table of symbols used	10
4. Introduction	12
5. Installation	13
5.1 Osicus Program Installation	13
5.2 Osicus Driver Installation	18
5.3 Installing the Hardware	20
5.4 Check Installation.....	21
6. Preparing the System.....	22
6.1 Starting the program	22
6.2 Introducing the Home Screen.....	22
6.3 Perform Machine Checks.....	23
6.4 Select Audiometer	23
6.5 Settings	24
6.6 Tester Information	25
7. Subject Details	26
7.1 New Subject	26
7.2 Find Subject	27
7.3 Comparison of Audiograms	29
7.4 Predictive Analysis	29
8. Running Hearing Tests	30
8.1 Calibration check	30
8.2 Patient Preparation.....	30
8.3 The Testing Screen.....	31
8.4 Automatic Operation	32
8.5 Manual Operation.....	32
8.6 Audiograms and HSE Categories.....	32
8.7 Comparison of Audiograms	33
8.8 Printing Audiograms	33
9. Categorisation of Results – H&SE Categories	34
10. Troubleshooting and Error Messages.....	36
11. Factors which affect absolute accuracy.....	37
12. Maintenance / Technical Information.....	37
13. Calibration	37
14. Cleaning	38
14.1 Instrument Enclosure	38
14.2 Patient Contact Parts.....	38
15. Supplied Parts.....	39
16. Spare Parts and Consumables.....	39
Appendix 1: Guidance on the Electromagnetic environment in which to operate the instrument.	40
Appendix 2: Technical Information (relative to EN 60601-1:2006+A12:2014)	44

Osicus Audiometer User Manual

© 2025 GM Instruments Limited

Reproduction, transfer, distribution or storage of part or all of the contents in this document in any form without the prior written permission of GM Instruments Limited is prohibited.

Osicus is a trademark of GM Instruments Limited. Other product and company names mentioned herein may be trademarks or trade names of their respective owners.

GM Instruments Limited reserves the right to make changes and improvements to any products described in this document without prior written notice.

Under no circumstance shall GM Instruments be responsible for the loss of any data or income or any special, incidental, consequential, or indirect damages howsoever caused.

The contents of this document are provided 'as is'. Except as required by applicable law, no warranties of any kind, either expressed or implied, including but not limited to, the implied warranties of merchantability and fitness for a particular purpose, are made in relation to the accuracy, reliability, or contents of this document. GM Instruments Limited reserves the right to revise this document or withdraw it at any time without prior notice.

Warranty

This warranty is extended to the original purchaser of the audiometer by GM Instruments Ltd, through approved Distributors or through GM Instruments Ltd, and covers defects in materials of workmanship for a period of 1 year from the date of delivery to the original purchaser.

Defects will be corrected at no cost to the purchaser within the first year, except for shipping charges to and from the point of service. This warranty does not apply to those parts that are subject to normal wear and tear, such as cords, ear cushions and headbands. Replaceable parts which may deteriorate with use will be supplied at a reasonable cost.

The manufacturer's warranty is void if the audiometer is repaired by persons other than GM Instruments Ltd or an approved Distributor.

The terms of this warranty do not affect your statutory rights.

1. Osicus Audiometer Important Safety Information



Read this Operating Manual before attempting to use the Instrument.

Warnings

This Instrument is for indoor use only and it should only be used as described in this manual.

The system must not be used in the presence of flammable gases or in an environment, which is susceptible to explosions. (Beware of oxygen, dust and anaesthetic gases)

This unit is powered by the USB from a PC or laptop. It is advisable not to touch the patient while using the equipment.

The equipment should be positioned in such a way that it can be easily disconnected from PC or laptop. The operation of the system can be safely terminated by removing the USB cable.

If your desktop PC or printer does not have a power supply approved for a patient environment, then an isolation transformer, which is in compliance with BS EN 60601, should be used to power the PC, printer and the Osicus. You must use the isolation transformer to ensure that the Osicus is in compliance with BS EN 60601.

Applied Parts. The Applied Parts are the headset and the response button.

Connect only items that have been specified as part of, or specified as being compatible with the Osicus Audiometer. Supplied and compatible spare parts and accessories are listed in Section 15 & 16 of this manual.

“WARNING The use of PC and Printer in the Patient Environment is defined below and must be followed to ensure safety compliance of the instrument.”

Option 1: Patient Environment for Non – Medically approved PC & Printer

If the PC and/or printer are not medically approved then NV2 should be positioned as shown below, outwith the patient environment. The PC and/or printer must be compliant to EN60950-1.

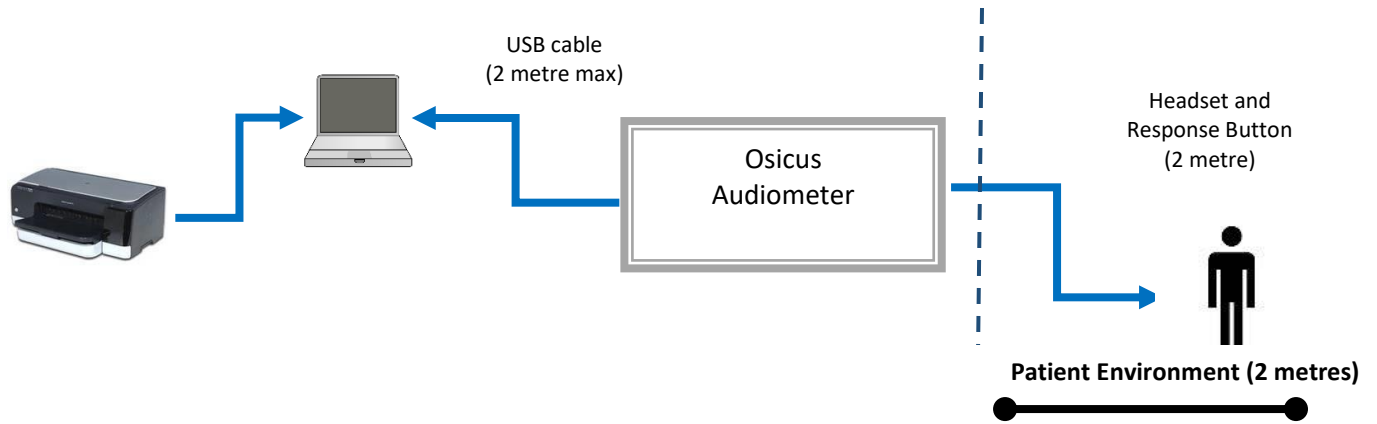

Figure 1: Patient Environment for Non-Medically approved PC & Printer

Option 2: Patient Environment for Medically approved PC & Printer

If the PC and/or printer is compliant to BS EN 60601-1 and medically approved, then the Printer and PC can be positioned within the patient environment as shown below.

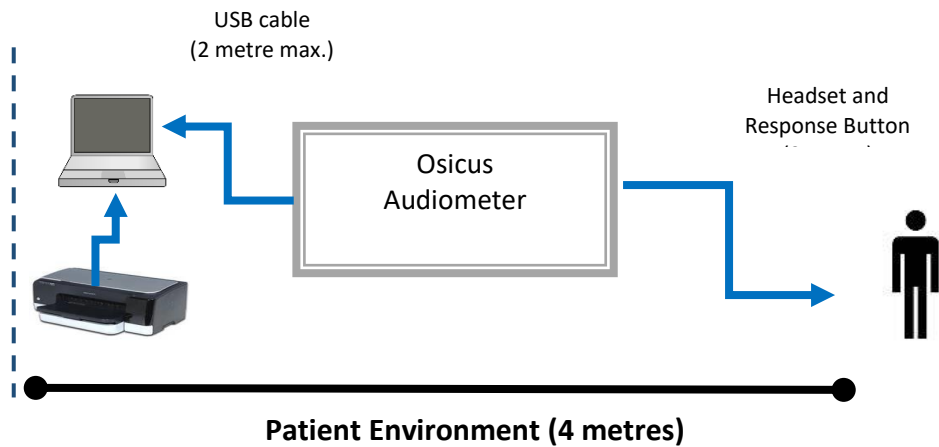

Figure 2: Patient Environment for Medically approved PC & Printer

In circumstances where the PC and /or printer are not medically approved but are to be used within the patient environment then an isolation transformer, which is in compliance to BS EN 60601-1 MUST be used to ensure safety compliance, or run the PC on battery power without mains connection.

CAUTIONS

Federal (USA) law restricts this device to sale by or on the order of a physician.

The use of the Osicus near to sources of electromagnetic radiation, such as mobile phones, radio transmitters, x-ray equipment etc, may prevent it from functioning correctly. Appendix 1 provides guidance on the Electromagnetic environment in which to operate the instrument.

This is a medical instrument, which has an electrical classification of Class II Type B and a Medical Device Directive classification of Class IIa.

A Class II Type B device categorisation is used to describe an instrument which: -

- a) Electrical equipment in which protection against electric shock does not rely on BASIC INSULATION only, but in which additional safety precautions such as DOUBLE INSULATION or REINFORCED INSULATION are provided, there being no provision for protective earthing or reliance upon installation conditions and
- b) Applied parts offer protection to the subject against electrical shock and in the event of a single fault condition arising, leakage current will be limited to less than 0.5 mA.

Any incident, which results in actual or potential injury or death to a subject while using the Osicus should be immediately communicated to GM Instruments at the address below.

The Osicus should only be connected to other mains powered devices such as computers and printers, which comply with EN 60950-1 and we also advise the use of a separating transformer. Unless computers and printers built to EN 60950 are used, patient safety might be compromised.

Non-medical equipment such as computers and printers should be kept out of reach of subjects being tested as such equipment does not comply with medical safety standards. Refer to clause 16 of EN 60601-1:2006 to ensure compliance.

If the PC is allowed to go in to sleep mode, the USB interface is powered down. When brought out of sleep mode, the PC does not re initialise the USB interface, and therefore it is effectively not present. A solution is to remove the USB connection at the PC or instrument side then re connect. That may be sufficient, but if not, save any results, then close down the instrument software and restart it



Servicing can only be carried out by GMI approved and authorised personnel. No modifications are allowed.

2. Technical Specification

No modification of this equipment is allowed. Factory-trained personnel or engineers familiar with the standard EN 60601 can only undertake servicing of the Osicus Audiometer. Circuit diagrams will be made available to competent persons on request.



Medical UKCA Mark	The UKCA mark indicates that the device meets the requirement of Annex V & VII of the Medical Device Directive 93/42/EEC. Approval of the Quality System is made by BSI whose notified body number is 2797	
Standards	Safety	BS EN 60601-1 Class II Type B applied parts
	EMC	BS EN 60601-1-2
	Audiometer	BS EN 60645 -1, Type 4
	Categorisation	UK & Ireland H&SE
Operation Environment	Temperature	15°C to 35°C
	Relative Humidity	30% to 90%
	Ambient Pressure	98kPa to 104kPa
	Warm up time	5 Minutes
Transport & Storage	Storage & Transport	-40°C to +60°C
	Relative Humidity	30% to 90%
Supply Power	Voltage	+5V DC from USB
	Current	0.2 A
Tone Type	Tone switching -Tone Presentation -Tone Interruption -Pulsed	Automatic Mode
	Tone Switching -Pulsed	Manual Mode
	Response	Required during TONE or as set by the user from the Options menu
Frequency Range	Discrete Frequencies and Maximum Outputs	250Hz (90dB), 500Hz (90dB) , 1KHz(90dB), 2KHz(90dB), 3KHz(90dB), 4kHz(90dB), 6KHz(90db), 8KHz(90dB)
	Accuracy	≤0.2%
	Total Harmonic	≤1%
Test Type	Auto Threshold	Hughson Westlake
Intensity	Range	-10 dB to +90dB
	Accuracy	≤1%
	Rate of Change	40 ms
	Duty Cycle	Continuous
	Intensity Limit	The tones are limited to 90dB HL
Headset	Earphones, Cushions & Audio cups	TDH39P / DD45 (10 ohm impedance) with MX41/AR Cushions and AO22 Audio cups.

Mechanical	Dimensions	13x 8 x 4 cm
	Weight	0.2 Kg
Calibration	Frequency	Annual calibration required by Manufacturer or Manufacturer approved provider
	Method	ISO 8253-1: Calibration undertaken using Referenced Transducers and Acoustic Coupler – see calibration
EMC	Effects	Please refer to page 7 and Appendix 1 of this manual
Service Life	Safety and Performance	The service life of the Osicus has been evaluated to be 10 years from the date of manufacture.

*** Additional Technical Information (relative to BS EN 60601-1) is also provided in Appendix 2**

3. Table of symbols used



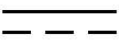

The following symbols appear on the Osicus or the mains adaptor





Symbol	Meaning	Socket Type	Location	Connected Part
	Refer to Instruction Manual ISO 7010-M002	USB Type B	Instrument Back Panel	Computer (Via USB Port)
	Type B Applied Parts IEC 60417- 5840	Jack Plug	Instrument Back Panel	Right and Left Input Socket Response Button *
	Direct Current IEC 60417 - 5931	—	Instrument Label	Computer (Via USB Port)



For connected parts marked * only connect the accessories supplied with the instrument. These parts have been tested for use with the instrument for compliance to standards IEC 60601-1 and IEC 60601-1-2.

Symbols used on labelling and packaging

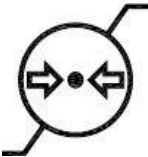
Symbol	Meaning	Location
	Manufacturer BS EN ISO 15223-1	Instrument Label
	Serial Number BS EN ISO 15223-1	Instrument Label
	Consult Instructions for Use BS EN ISO 15223-1	Instrument Label
	UK Conformity Assessment	Instrument Label

	<p>Temperature Limit</p> <p>BS EN ISO 15223-1</p>	<p>Instrument Shipper Packaging</p>
	<p>Humidity Limitation</p> <p>BS EN ISO 15223-1</p>	<p>Instrument Shipper Packaging</p>
	<p>Atmospheric Pressure limitation</p> <p>BS EN ISO 15223-1</p>	<p>Instrument Shipper Packaging</p>
	<p>Mandatory Action Sign</p> <p>ISO 7010- M001</p>	<p>Operating Manual</p>

ADDRESS AND CONTACT DETAILS:

MANUFACTURED BY:
 GM Instruments Ltd
 Block 1 Annickbank Innovation Campus
 Annick Road
 Irvine
 KA11 4LF
 UK
 TEL: +44 (0)1294 554664
 EMAIL: sales@gm-instruments.com
 WEBSITE: www.gm-instruments.com

4. Introduction

The Osicus Audiometer is a medical device used to screen subjects for noise induced hearing loss.

It is intended that the Osicus will be used as part of a hearing screening program in industrial and corporate environments. The hearing screening will measure the hearing threshold of a test subject and indicate the need for further clinical analysis and treatment. The Osicus is a stand-alone product and is not intended to be used with other medical devices.

The operator of the Osicus is expected, as a minimum, to be a competent person. Competent persons have completed courses with syllabi determined by the British Society of Audiology. These courses familiarise them with audiology, the methods of performing hearing testing and how to operate and maintain audiometers. Other users may be more skilled experts in audiology, such as Occupational Health nurses and audiologists.

The subject, upon whom the hearing testing is performed, is expected to be an employee working in high noise environments being screened in line with the Health and Safety Executive's regulations on noise at work, or being routinely screened as a part of a workplace health programme. Subsequently, they come from all walks of life and are of working age.

The Osicus audiometer is expected to be used in an environment suitable for the conduction of hearing testing. Most likely a quiet office or a room fitted out with a hearing test booth.

The process follows the British Society of Audiology approved procedures for the determination of Pure Tone thresholds, using the Hughson Westlake technique. The headphones rest on the outside of the head of the test subject and shall transfer sound energy to the subject by air conduction. The subject holds the remote switch and presses it when tones are heard.

Once thresholds have been determined for both ears on selected frequencies, and the age and gender of the subject being tested has been input, the audiogram is categorised according to the Health & Safety Executive categorisation scheme.

5. Installation

5.1 Osicus Program Installation

This installation manual is for use during the installation of Osicus. It will guide you through installing the Osicus and connecting the audiometer for use with the Osicus software.

Along with this manual you will find the following items in the box:

- A sound module
- A set of headphones
- A response switch
- A USB cable
- A USB memory stick containing software
- Osicus User Guide
- Laminated Short Form User Guide

There are three parts to the installation and they should be performed in the order noted below:-

- 1) Load the audiometer software
- 2) Install the drivers for the USB
- 3) Connect the audiometer to the computer using the USB Cable

Insert the USB memory stick into the USB port on the computer, then open Windows Explorer, and navigate to the USB drive.

There you will find 4 folders, named
Osicus Installation Files
Osicus 2 Drivers
Dotnetfx
Manuals

NB Do not connect Osicus to the PC until all program software and USB driver software installation has been completed.

Software (Windows 10 and earlier)

Open the folder Osicus Installation and click on setup.exe. Installation will begin unless the following problems are advised.

If your PC does not have the Microsoft .NET framework and/or Windows Installer 3.1 present, the installation will not take place and a message on screen will advise of this. To rectify the problem, return to the USB memory stick, open the folder Dotnetfx and click on setup.exe to install the missing programs.

If a version of Osicus has already been installed on your PC, you will be advised and the new installation will stop. Any previous versions of the software should be removed using the Add/ Remove Programs utility in the Control Panel, and then the Osicus installation program should be run again. Uninstalling Osicus will not remove the Osicus result files, which by default will be found in c:\audio\results.

Assuming all is well the screens you will see during installation are shown below:-

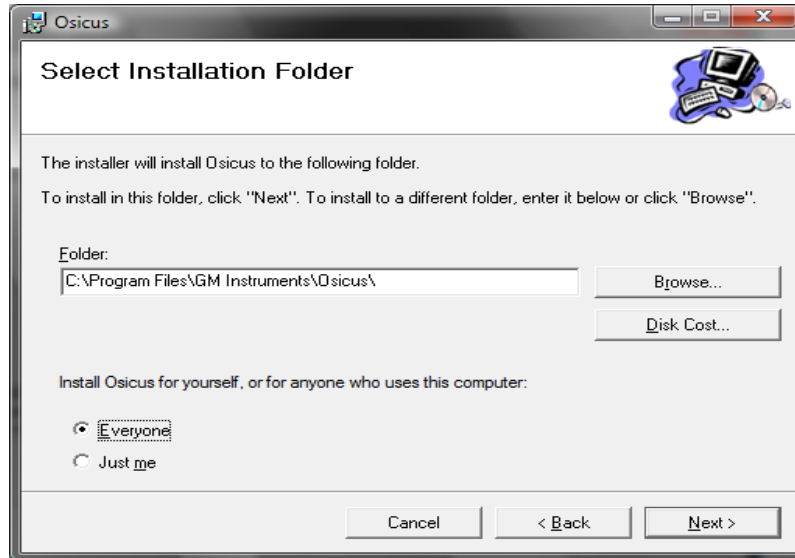

Figure 2.1.1 Select Installation Folder

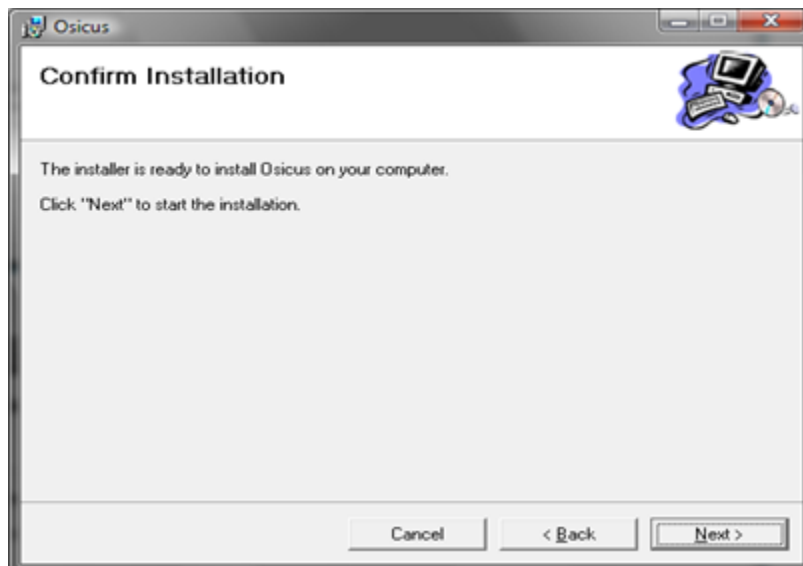

Figure 2.1.2 Confirm Installation

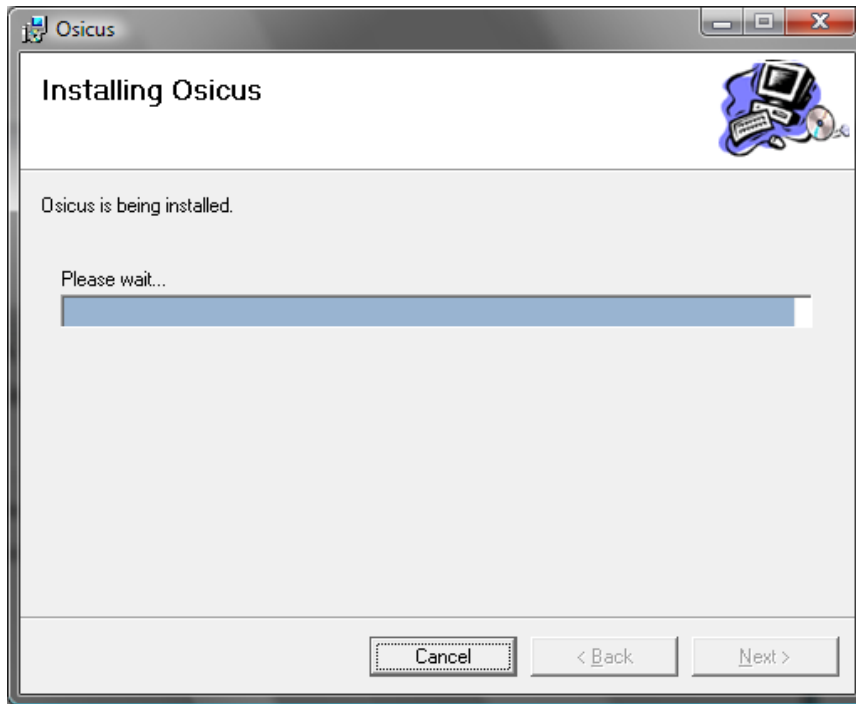

Figure 2.1.3 Installing Window

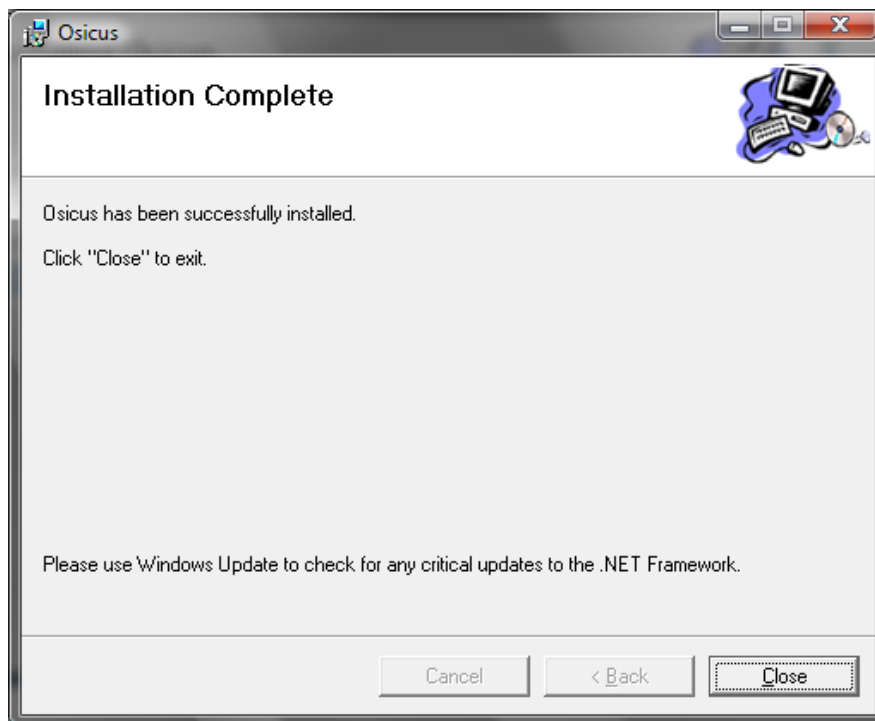

Figure 2.1.4 Installation Complete Window

Windows 7/8 Osicus Settings Saving Error

Windows 7 & 8 automatically sets the folder in which the program settings are saved to be write protected. This results in the following error message upon exiting the Osicus Solo program. This will result in the settings you have selected in the Osicus Solo program not being saved for next time you use the program.

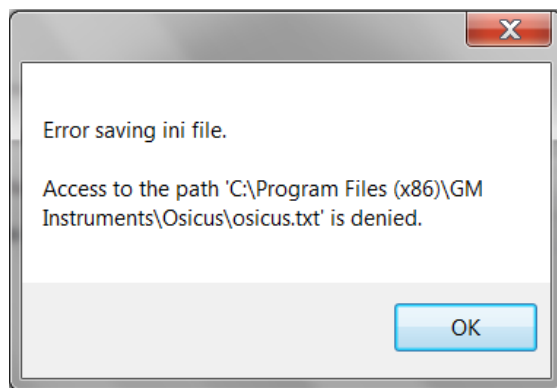

Figure 2.2.1 Read Only Error Message

To rectify this issue you will need to change the Osicus folder from being read-only.

To do this, navigate to Computer – C Drive – Program Files (x86) – GM Instruments. Right click on the Osicus folder and open the properties menu.

Next you will need to ensure you have the permission to modify this folder. Open up the Security tab and select the user that you are currently signed in as. Check to see if 'Full Control' is allowed. If it is not click on Edit to change permissions.

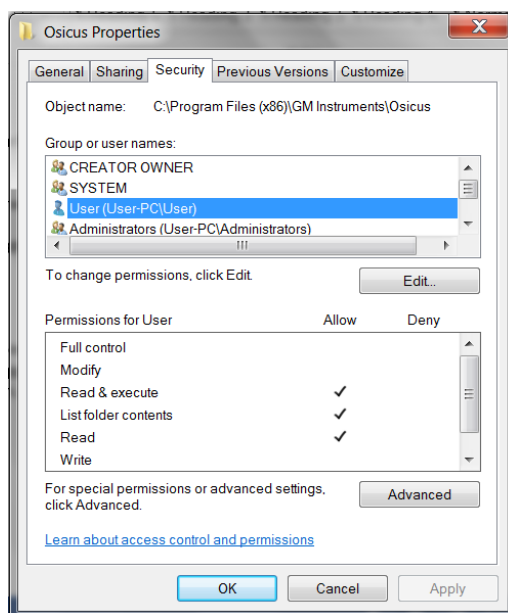

Figure 2.2.2 Osicus Folder Security Tab

In the Edit window, select the user you are currently signed in as and tick the Allow box for Full Control. Click Apply and then click OK.

If the boxes are greyed out and you are not able to change them, you will need to get someone with administration rights to make this change for you.

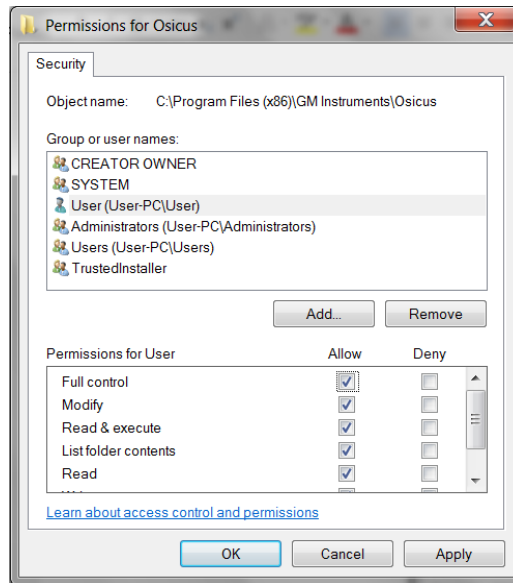

Figure 2.2.3 Edit Permissions Window

Next, navigate back to the General tab of the Osicus Properties window. Uncheck the 'Read Only (Only applies to files in this folder)' button, press Apply and then OK. A confirmation window will then appear. Click OK. The Osicus solo program will now save your settings for the next time you use the program.

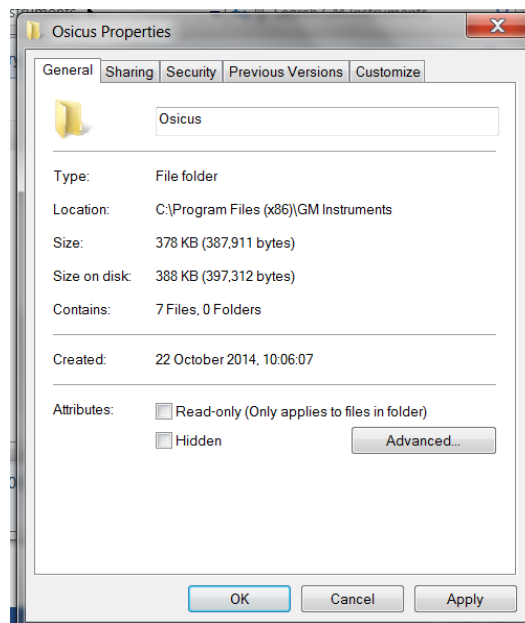

Figure 2.2.4 Osicus Folder Properties

5.2 Osicus Driver Installation

For correct operation the drivers should be installed **BEFORE** connecting the audiometer to the computer.

To install the drivers open the 'Osicus 2 Drivers' folder on the USB drive supplied and click on USBdriver-amd64.exe to run the Device Driver Installation Wizard. A window may appear asking if you want to let the program make changes to your computer. Click yes.

If you are using a 32 bit computer click and run USBdriver-x86.exe installation wizard instead. The Device Driver Installation Wizard will then open. Click on Next to continue.



Figure 3.1.1 Device Driver Installation Wizard Start Up

The installation wizard then installs the drivers onto your computer. As this is happening, a windows warning message appears. Click on 'Install this driver software anyway'. As there are two drivers to install, this warning message will appear twice.

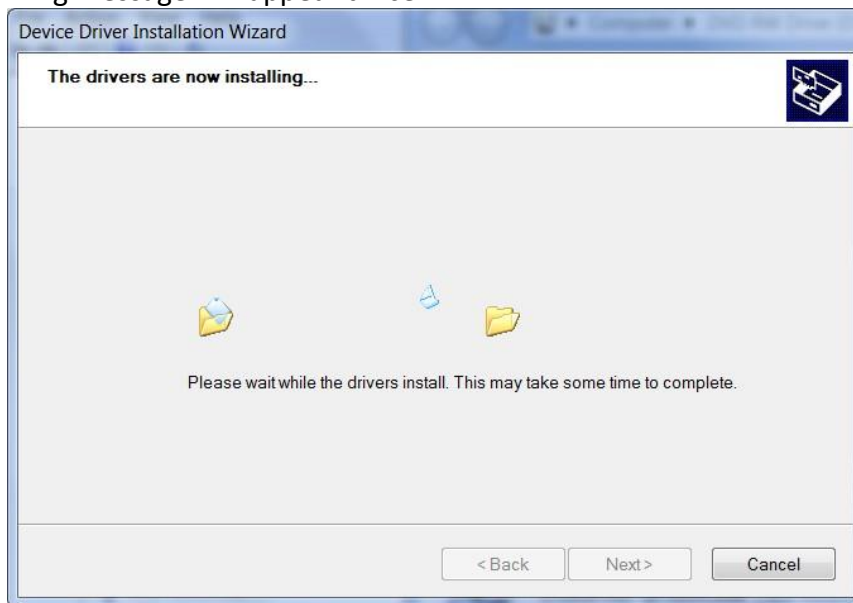

Figure 3.1.2 Driver Installation In Progress



Figure 3.1.3 Verification Warning Window

Once the installation has finished click on 'Finish' to close the installation wizard. You are now ready to connect the audiometer to the computer.

When you first connect the audiometer to the computer, a prompt will appear on the bottom left corner of the screen stating that windows is installing the drivers. A second prompt will appear in the same place when the Osicus has enumerated the drivers, stating that the drivers were successfully installed for this device. This prompt may appear after a slight delay, the length of which will depend on how fast your computer runs. You are now ready to start running tests with the audiometer.



Figure 3.1.4 Driver Installation Complete

Correct installation of the USB drivers can be confirmed through the Device Manager utility as shown in Figure 3.2.7. To open Device Manager, go to Control Panel > System, then select the Hardware tab and click on the Device Manager button. Note that there are two entries for the Osicus USB Audiometer.

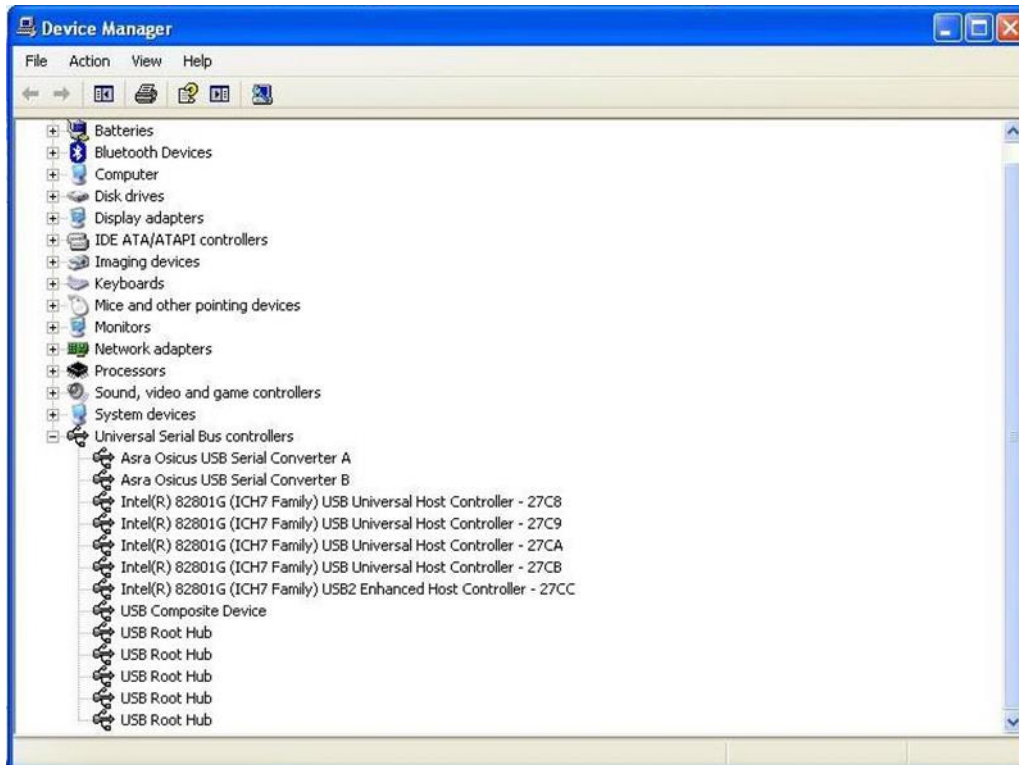

Figure 3.2.7: Device Manager

On subsequent connection of the audiometer, the USB drivers will be recognised automatically and no user interaction will be required.

5.3 Installing the Hardware

Operation of the Osicus audiometer is controlled by software running on a Windows based PC.

The link between PC and Osicus is by means of a standard USB cable.

The other connections on the front of Osicus, which are essential for its correct operation are:-

- Headphone plug - **if a booth is used**, link the socket marked "Headphone" on the front of Osicus to the booth with a stereo booth cable and connect the Osicus earphone plug to the corresponding socket inside the booth. **If no booth is available**, connect the red plug directly into the socket marked right.
- Switch - Response button plug – **if a booth is used**, link the socket marked response on the back of Osicus to the black socket on the booth and connect the response button plug to the corresponding black socket inside the booth.

If no booth is available, connect the response button plug directly into the socket marked response.

5.4 Check Installation

- Close down PC and log on as an ordinary user.
- Check the Osicus icon is on the desktop
- Double click on each icon in turn to check that the programs run ok.
- In the Home Screen, click “Select Audiometer” and check that the audiometer and headphone serial numbers match with those connected
- In the Osicus testing program Home Screen, select ***Perform Machine Checks***, follow the instructions, and confirm the Osicus is functioning and receiving response correctly
- Click on print to check the operation of the printer.

The system is now ready for use

6. Preparing the System

6.1 Starting the program

You will find an icon on your desktop and by clicking on START/All Programs, with the title Osicus Solo. Clicking on this will start the program.

6.2 Introducing the Home Screen

The Home screen is the central point where the functions of the audiometer can be accessed. Clicking on the Home icon at any time will return you to the Home screen. From the Home screen, you can create New records, Find records, Run Tests and Exit the program, all by clicking on the associated icon.

Additionally you can prepare the audiometer for use by using the 4 setup buttons – Perform machine Checks – Select Audiometer – Settings – Tester Settings. The following chapter takes you through these functions.

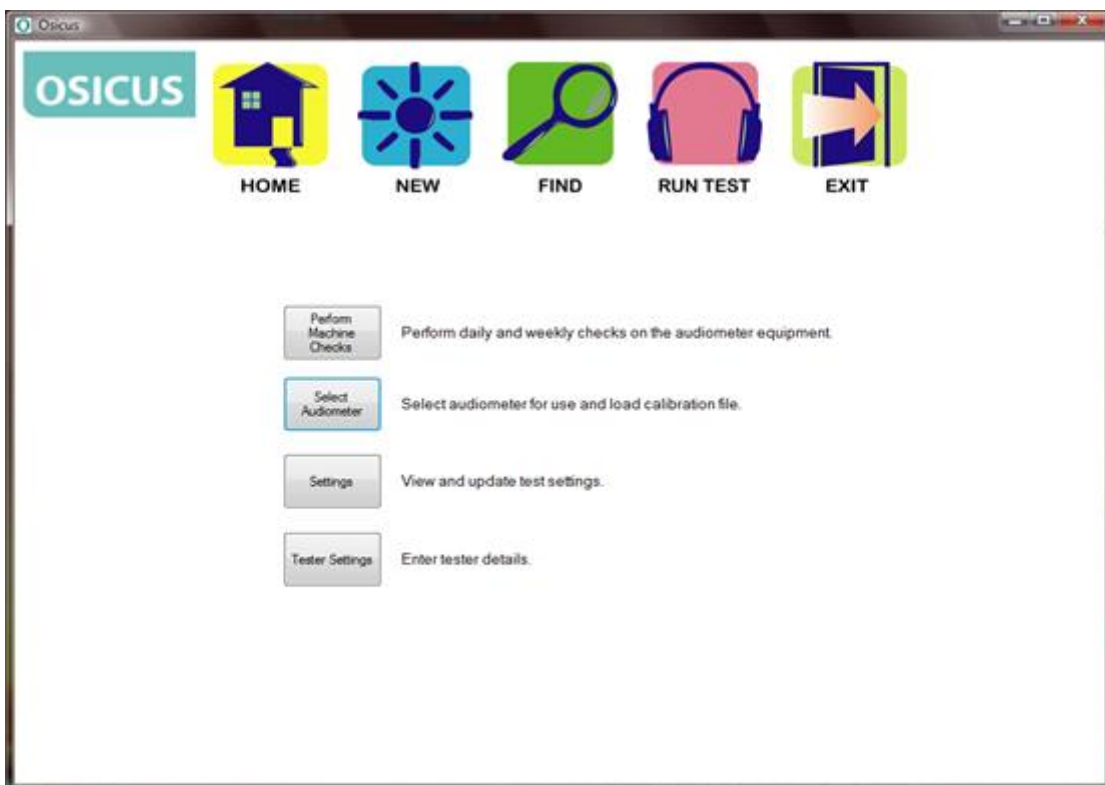

6.3 Perform Machine Checks.

When you click on the start button, the system presents a series of tones at whatever level you select in one ear, followed by the other, and logs your response to the tones. This allows you to hear each frequency, listening for distortion or a change in level. If you click on Save, the responses to the test tones will be saved to a file for record keeping purposes.

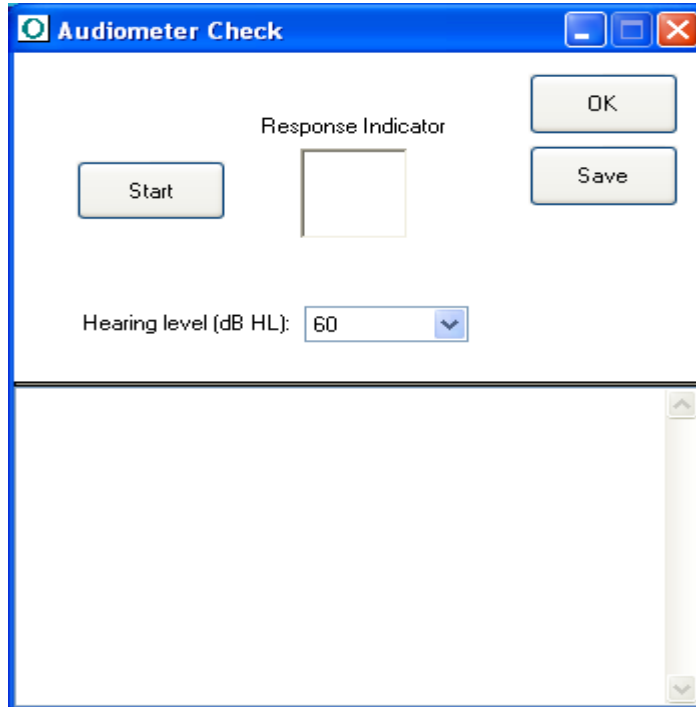

6.4 Select Audiometer

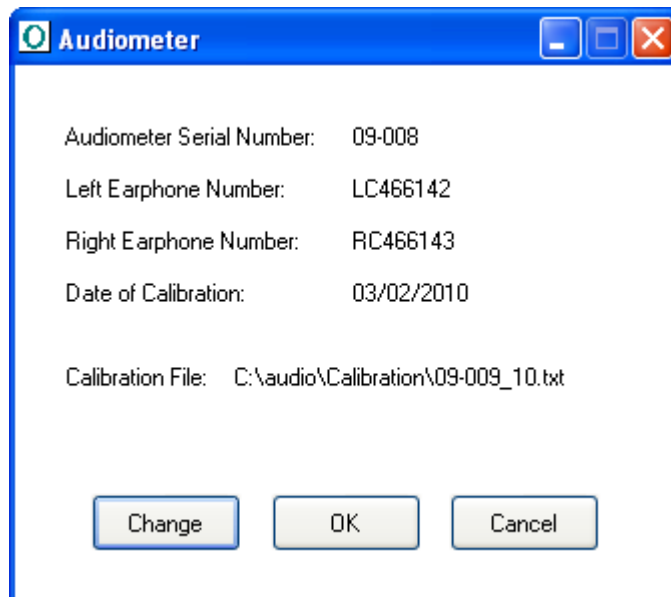

Viewing this screen allows you to check that you are using the correct audiometer/earphone combination and that the calibration file is up to date.



An audiometer is calibrated with one set of headphones. The audiometer number and matching headphone numbers are stored during audiometer setup. The audiometer should only be used with the headphones used during calibration.

If the audiometer number is incorrect, click on the Change button, then select the correct audiometer from the list. If the audiometer is not listed, then its details must be added by loading in a new calibration file. Now click on OK to move to the next screen.

To guarantee accuracy, each audiometer must be calibrated at least once each year and receive an exhaustive calibration every two years. The date of last calibration is displayed with the audiometer details.

After calibration, you will be supplied with a file containing calibration information. To update the calibration information, press the Change button, browse to this file and click on Ok.

6.5 Settings

The location of the Calibration File and location where audiograms generated will be saved are specified here. Note that if you wish to analyse audiograms generated by different groups of workers, either from the same company or from different companies, using the optional Asra Batch_UTILITY software, you should create a folder for each group and set the appropriate folder using this screen prior to testing.

Other test settings such as the frequencies tested, the tone characteristics, the threshold determination criteria, and order of ear testing can all be altered from within this dialogue.

Shortening the test time increases the possibility that the subject will be able to retain concentration for the duration of the test, and therefore produce the most favourable and accurate result. We recommend testing the frequencies listed above, with a tone length no greater than 1.5 seconds and a threshold search criterion based on 2 from 3 responses.

The “Number of Matching responses” setting is explained as follows. After the first response to a tone has been received, the threshold criterion for “3 out of 5” collects the hearing levels at which a response occurs on the ascent. After each such response the buffer of responses is evaluated for containing three matching levels. When there is a match the threshold for the current frequency is recorded to the audiogram at that level. For example this could be 35-35-35 (generating the result of 35dB) or 40-35-35-40-40 (generating the result of 40dB). Up to five responses will be held for evaluation. In case no threshold could be found (e.g. with levels 30-40-35-30-40) after five responses the software will clear the buffer and initiates a new pass of "3 out of 5" at the "start level" intensity. The logic is the same for the “2 out of 3” setting for "number of matching responses". When the “average if no agreement in two passes” checkbox is not selected, this routine will repeat indefinitely until a result is achieved. Alternatively, the checkbox can be selected which will generate a threshold at the average level of the obtained responses after two unsuccessful passes of “3 out of 5”, or “2 out of 3”. For example, a second attempt response sequence of 30-40-35-30-35 will generate a threshold at 34dB. The user will receive a warning message if the threshold is going to be calculated this way.

6.6 Tester Information



The image shows a screenshot of a software dialog box titled "Tester Details". The dialog box has a blue title bar with the text "Tester Details" and standard window control buttons (minimize, maximize, close). Inside the dialog, there are two text input fields. The first is labeled "Name:" and contains the text "John Brown". The second is labeled "Company:" and contains the text "GM Instruments Ltd". At the bottom of the dialog, there are two buttons: "OK" and "Cancel".

Enter the name of the person who will be doing the tests, and the company they represent.

7. Subject Details

7.1 New Subject

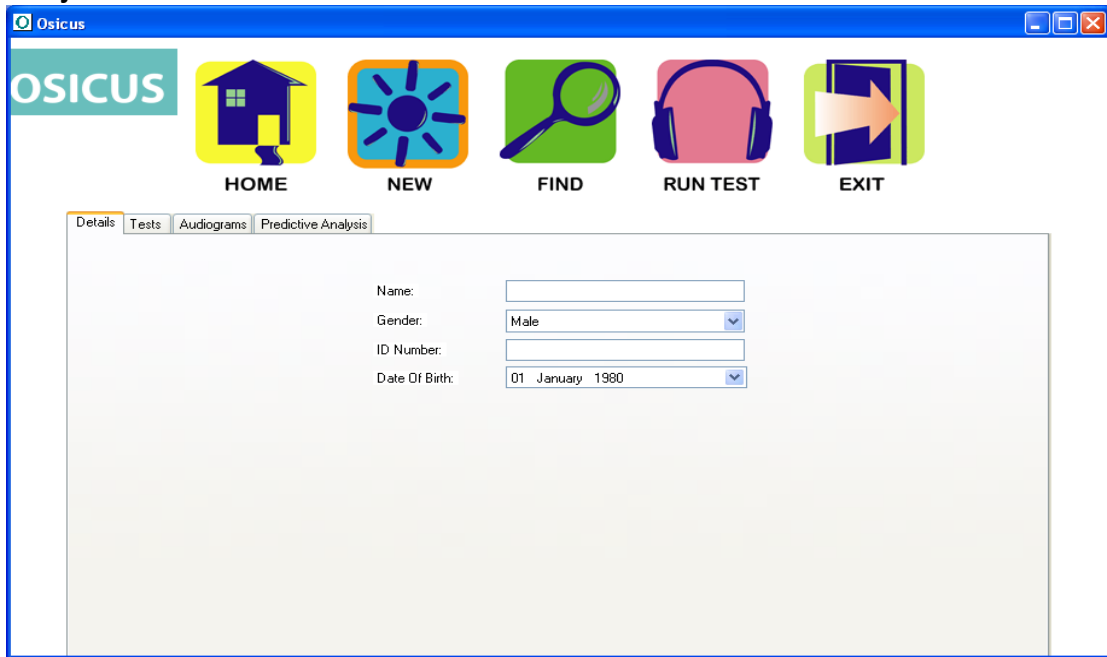

When you click on New, a screen which allows the entry of Name, Gender, ID Number and Date of Birth is offered.

Name:- Enter details as First name Last name.

Gender:- Use the menu to select.

ID Number:- Letters or numbers are accepted for entry, but as the content of this field is used as the unique identifier for the Asra Batch Utility software and Occupational Health Databases such as Opas or Cohort, it is important to enter this detail carefully.

Date of Birth:- Enter the date of birth to allow the program to calculate the age of the person being tested. The preferred format is DD/MM/YYYY

An example of a completed screen is shown below

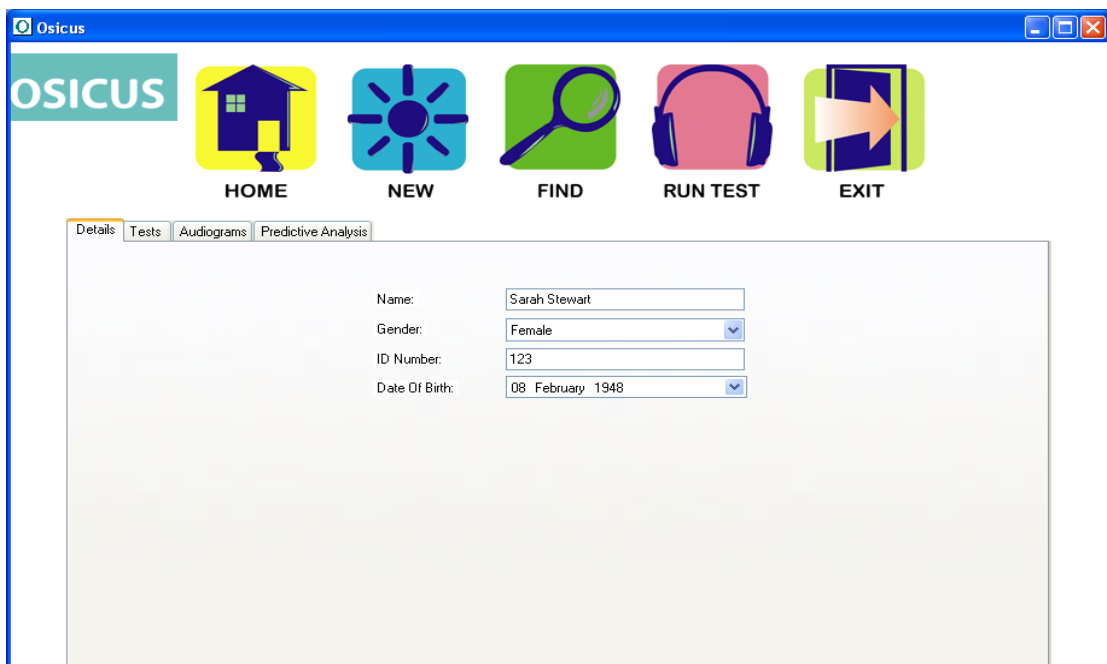

7.2 Find Subject

Find Person

Search Files

First Name:

Surname:

Personnel Number:

Date of Birth:

Find Select

or Open File

Open File: Browse...

Change Directory

Directory: Browse...

Include Subdirectories

The search can be based on the content of a particular folder/directory and its sub folders/directories.

It can be done manually by clicking on browse or it can be done automatically by entering the Surname or an ID (Personnel) Number. An example of a search based on partial ID is shown below.

Find Person

Search Files

First Name:

Surname:

Personnel Number:

Date of Birth:

Find Select

or Open File

Open File: Browse...

FileName	PersonName	IDNumber	DateOfTest
C:\audio\results\...	Eric Greig	12345	31/03/2010
C:\audio\results\...	Eric Greig	12345	31/03/2010
C:\audio\results\...	Eric Greig	12345	31/03/2010
C:\audio\results\...	Eric Greig	12345	14/02/2009
C:\audio\results\...	Sarah Stewart	123	30/06/2008

Change Directory

Directory: Browse...

Include Subdirectories

Having found the person you want, highlight the entry and click on Select.

The screen shown below will then become available and you have the option of using the Details/Tests/Audiograms tabs to view the previously generated data.

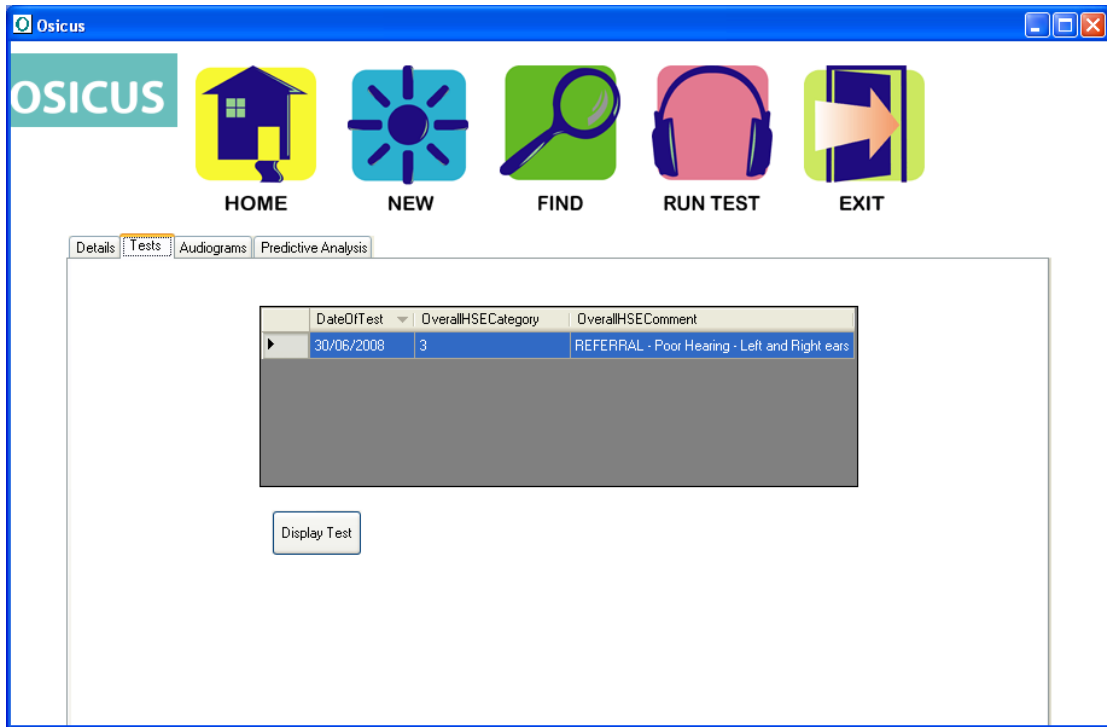

The details tab will show the Subject information entered.

The Tests tab will show all of the stored audiograms for the selected person. If you want to view a particular audiogram, select it and click on Display Test or click on the Audiograms tab.

An example of a completed audiogram, brought back from saved records is shown on the following page.



Below the audiogram is shown the HSE Category. HSE Categories are explained further in Section 10.

To print the audiograms, click on the Print button.

7.3 Comparison of Audiograms

To compare the selected audiogram with another, click the Compare Audiograms button. A further window will open to allow you to select the audiogram to be compared with the previously selected one. Highlight the one you want and then click on the Select button. Both will then be shown superimposed.

7.4 Predictive Analysis

Predictive Analysis is one of the unique features of the Asra Osicus software. Hearing test data can be analysed by intelligent algorithms and future hearing trends can be predicted.

The predicted audiogram shows how the intelligent analysis thinks the subject's audiogram will look in a year's time. It assumes no change in hearing protection or in the current working noise environment. Although analysis is made to the highest possible standards, there is no guarantee that the prediction is accurate, because many factors could influence the final outcome. However, it is often found to be useful in reinforcing the message that hearing conservation matters.

The current audiogram can be superimposed on the predicted by clicking on the Compare with Current Test button.

To print a report of the predicted results, press the Print button.

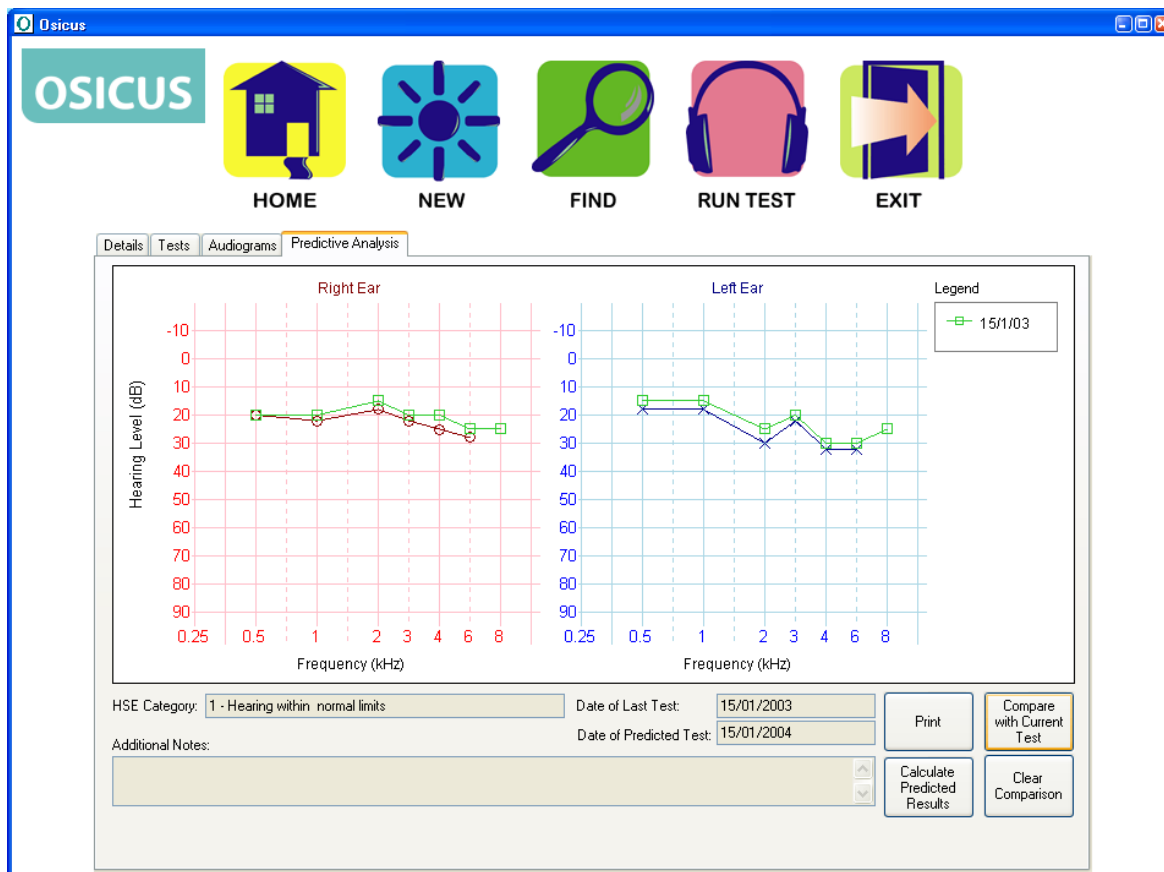

8. Running Hearing Tests

The Osicus can be used by any “**competent person**”, technician, nurse or doctor, who has been certified as having satisfactorily completed a competent persons audiology course.

Having become familiar with the hardware and software you are now ready to record measurements.

Having previously either entered details for a new person or selected someone who has been tested before, click on Run Test from the home screen. Before testing, you should ensure that the subject’s ears are not blocked, the audiometer is connected and has been tested and the headphones are correctly in place.

8.1 Calibration check

It is recommended that a calibration check is carried out at the beginning of the day prior to patient testing to confirm Osicus performs as expected.

To do a calibration check, switch on the Osicus, start the software and move to the testing screen. Enter Patient ID details if you want to save the calibration check.

Then either put the headset on an “artificial ear”, with the response cable replacing the response button unit or ask someone whose hearing level is known to put on the headset (remove glasses and earrings if they interfere with the fit of the headset). Advise them to press and release the button as soon as they hear the tone.

The **red** audiocup goes on the **right** ear and the **blue** headset on the **left**. Click on the **Test** button to start the test.

On completion compare the audiogram with the previously recorded audiogram for that “artificial ear” or test person.

It is always possible for any threshold point to move up or down by 5 dB, but if almost all points are further down the audiogram from previous results, the jack connections inside the booth and outside the booth (if a booth is being used), plus the jack connections at the back of the Osicus should be cleaned with an alcohol wipe and swiped in and out 10 to 20 times to clean them.

The test should then be repeated. If this does not restore the thresholds, then a cable problem might exist on the ear in question.

8.2 Patient Preparation

The patient should be prepared, prior to testing, by having them in a quiet stable environment for 5 to 10 minutes. This is a suitable time to take a history, complete your pre-test questionnaire and examine the ears for wax.

If they have recently been exposed to excessive noise, or have a cold prior to this appointment, a note to this effect can be made in the comments section of the program.

The headset should be put on the patient either themselves and the fitting checked by the operator, or by the operator to ensure that the earphones are centred over and enclose the ear.

The red audiocup goes on the right ear and the blue headset on the left. The headband should then be tightened to ensure that the cups do not move or slip.

The patient hold the response switch with the instruction to press the button when they hear a tone to indicate a response.

8.3 The Testing Screen

To use automatic operation, check that the Automatic Test tab is set as shown above and decide whether or not you want to have standard tone presentations or pulsed tone presentations. If pulsed, click on the Pulsed Tones tick box.

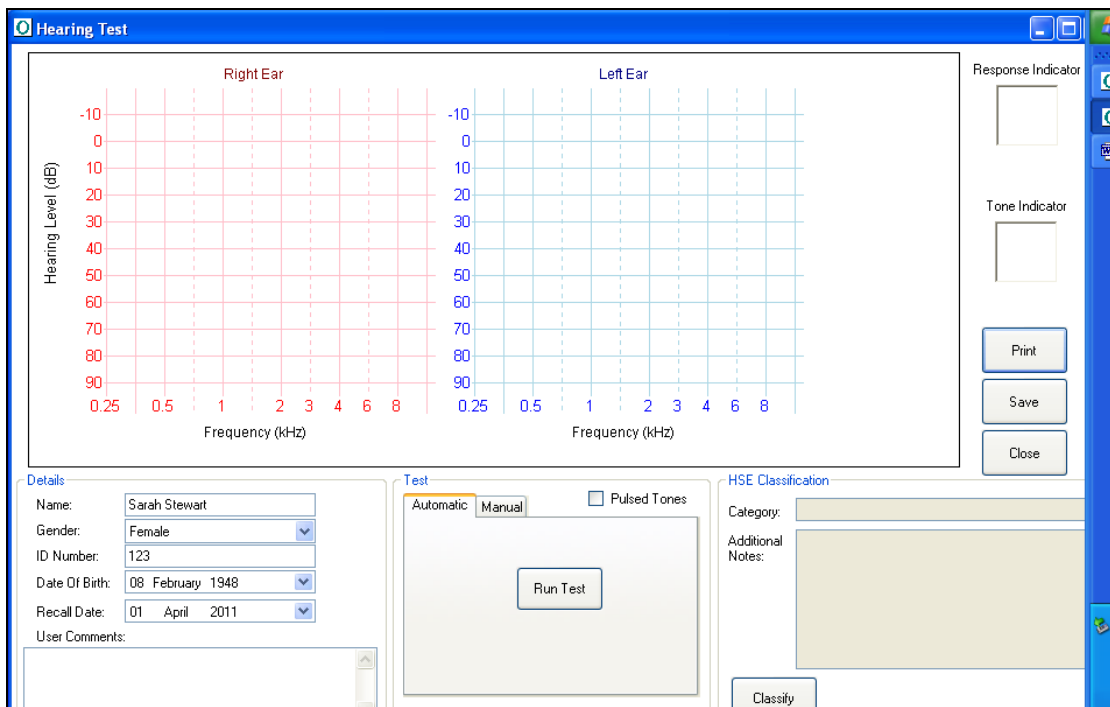

Home Screen

To start a hearing test click on the Run Test button. During the hearing test the subject will hear tones in one ear at each of up to eight different frequencies and then again in the other ear.

Each tone will increase in volume until the subject confirms that they have heard the tone by pressing the response switch. The system will run through this several times for each tone to ensure a consistent response. If there is no consistent response you will be notified by a message appearing on screen. As the test proceeds, the results will be plotted on the audiogram.

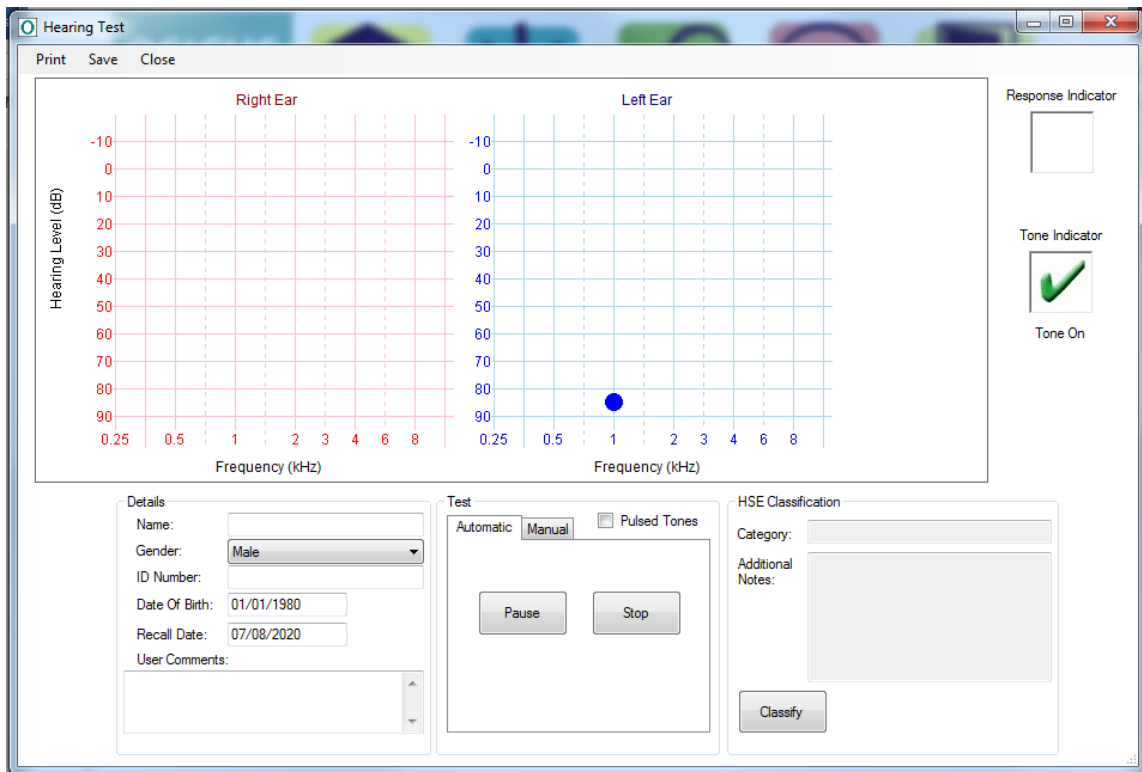

If at any point the test must be paused or stopped, use the buttons provided on the interface. Pressing Pause will temporarily stop the test, allowing it to be restarted at the current frequency. Pressing Stop will stop the test but retain all results up to that point.

8.4 Automatic Operation

The Osicus audiometer software is based on the Hughson-Westlake testing routine recommended by the British Society of Audiology. It has a number of additional features which combine to make Osicus a unique instrument, while still complying with the recommended procedures of the British Society of Audiology and the Health and Safety Executive. This section describes, among other things, the default settings in the program and the recommended steps in normal usage. It also gives a more detailed description of all the menu facilities which are provided in the program.

8.5 Manual Operation

To switch to manual operation, select the Manual Test tab as shown above:

To produce a tone, select the frequency, amplitude ear, and then press the Produce Tone button.

As each tone is produced, points will be plotted on the audiograms, showing the progress of the test.

The audiogram will show the last response at each frequency.

If no response is recorded at 90 dBHL this will be recorded as no response on the audiogram.

8.6 Audiograms and HSE Categories

Audiograms are the recognised method of displaying hearing test data. They are graphs showing the level at which the subject responded for each tone. Each ear is graphed separately.

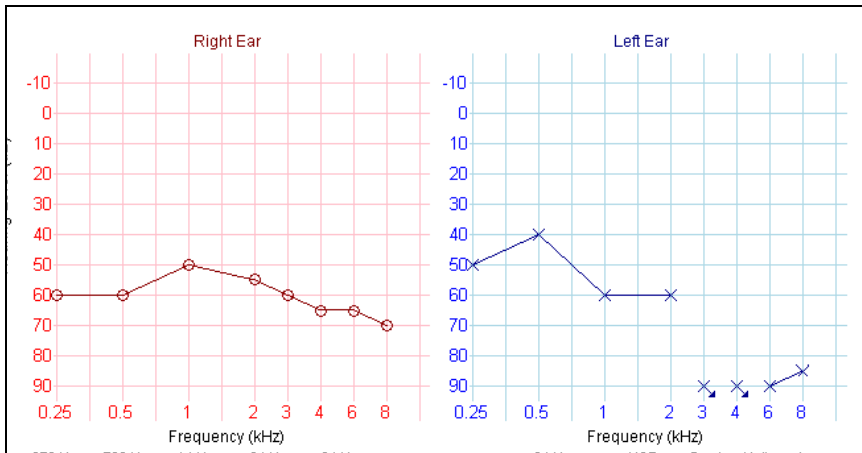

As the test proceeds, points are plotted on the audiogram, representing the test subject’s results. The above shows an example of audiograms for the left and right ears. The left ear audiogram is blue and points are plotted using crosses. The right ear audiogram is red with points plotted using circles. No response to a frequency is plotted at 90 dBHL (maximum amplitude) and the symbol includes an arrow pointing down. This is shown above at 3 and 4 kHz on the left ear.

At the end of the test, press the button to calculate the HSE categories.



Depending on the circumstances caution is recommended in discussing audiogram results and HSE Categories with subjects.

User comments can be added by typing in the User Comments box. These can relate to any observations during the test and will be printed on the audiograms.

The results must be saved to the database before exiting the test window. Results can be saved by pressing the Save button. The audiograms and related information can be printed as a report by pressing the Print button.

8.7 Comparison of Audiograms

To compare the selected audiogram with another, click the **Compare Audiograms** tab at the bottom of the testing window. A further window will open to allow you to select the audiogram to be compared with the previously selected one. Highlight the one you want and then click on the Select button. Both will then be shown superimposed. And can be toggled on/off using the tick box at the side of the test window.

8.8 Printing Audiograms

When you choose to print audiograms, a new window will open with a print preview of the report including any related personnel and test data. From this window you can choose to print the document to a selected printer, save the document to file or zoom in and out of the document.

9. Categorisation of Results – H&SE Categories

The Osicus program controls the acquisition of an audiogram, along with the employee's details, stores them in a file and displays them in the Results box on the audiogram screen and on the printout. It is therefore appropriate and easy that the program should also determine the Health and Safety Executive (H&SE) categorisations for the current audiogram, and display them in a similar way.

The Osicus testing program uses the categorisation scheme which was introduced in the year 2006 by the H&SE, and this implementation is described here.

The H&SE have done extensive analyses of the prevalence of Industrial Hearing Loss and its relationship to the threshold levels in an employee's audiogram. Based on the results of these analyses, the H&SE have drawn up tables of threshold levels above which Warnings or Referrals should be made.

These tables are used in the Osicus program to perform HSE Categorisation on an audiogram produced from hearing tests.

Sum of hearing levels 1, 2, 3, 4 and 6 kHz				
Age	Males		Females	
	Warning Level	Referral Level	Warning Level	Referral Level
18-24	51	95	46	78
25-29	67	113	55	91
30-34	82	132	63	105
35-39	100	154	71	119
40-44	121	183	80	134
45-49	142	211	93	153
50-54	165	240	111	176
55-59	190	269	131	204
60-64	217	296	157	235
65+	235	311	175	255

Classification of hearing levels into warning and referral levels.

Referrals to a General Practitioner or to a hospital audiology clinic are made in cases of poor hearing, when the thresholds are above the levels indicated in the Referral table below.

Warnings are given to the employee when the thresholds indicate mild hearing impairment, as indicated in the H&SE Warning table below. These levels indicate that the employee's hearing is not as good as might be expected at his/her age. The warnings state that greater care should be taken to use appropriate protective devices when working in a noisy environment.

For further guidance to the operator and as a further explanation to the employee, two dotted lines are drawn on each of the audiogram grids, both on the screen and on the printout. These indicate the approximate level for Referral and for Warning.

The H&SE recommend that each audiogram should be put into one of four categories, based on the threshold levels in the audiogram, and the age and sex of the employee. The frequencies normally used for this assessment are 1, 2, 3, 4 and 6kHz.

These recommendations are followed in the Osicus program, where the four categories, as they are described on the screen, are as follows.

Category	Calculation	Action
1 Acceptable Hearing Ability Hearing within normal limits.	Sum of hearing levels at 1, 2, 3, 4 and 6 kHz.	None
2 Mild Hearing Impairment Hearing within 20th percentile, i.e. hearing level normally experienced by 1 person in 5. May indicate developing NIHL.	Sum of hearing levels at 1, 2, 3, 4 and 6 kHz. Compare value with figure given for appropriate age band and gender in Table A1.	Warning
3 Poor Hearing Hearing within 5th percentile, i.e. hearing level normally experienced by 1 person in 20. Suggests significant NIHL.	Sum of hearing levels at 1, 2, 3, 4 and 6 kHz. Compare value with figure given for appropriate age band and gender in Table A1.	Referral
4 Rapid Hearing Loss Reduction in hearing level of 30dB or more, within 3 years or less. Such a change could be caused by noise exposure or disease.	Sum of hearing levels at 3, 4 and 6 kHz.	Referral
Unilateral Hearing Loss Suggesting a problem due to disease or infection	Sum of hearing levels at 1, 2, 3 and 4kHz for both ears. If the difference between the ears is greater than 40dB the individual should be advised of the findings.	Referral

The HSE Categorisation Scheme

1. NIHL: Noise Induced Hearing Loss
2. Reference: HSE Controlling Noise at Work The Control of Noise at Work Regulations 2005, pg 118 & 119.

10. Troubleshooting and Error Messages

No audiometry hardware detected

The computer does not recognise the audiometer. A number of things to check that could cause this:

1. Is the Osicus plugged in and getting power? Check device is listed under USB in device manager
2. Is the USB cable from the computer plugged into the back of the Osicus?
 - a. If not, close the program window down and plug in then restart the program.
3. Have the drivers been installed?
 - a. This can be checked in Device Manager in Windows. It should display and USB Serial Port (COM X) under Ports and USB Serial Converter under Universal Serial Bus controllers headings.
 - b. If the drivers have not been installed, close the program down, unplug the USB from the back of the Osicus. The follow the instructions in the Installation section of this manual.

File Not Saved!

The audiogram has not been saved ---Is the folder and the path to it (if saving over a network to a server) valid and does the user currently logged on, have permissions to save to it?

File already exists, Ok to overwrite?

You are attempting to overwrite an existing file with this one

No calibration data has been found

The program attempted to load a file from the folder which contains the program, but it has not been found. If you proceed the system will not be correctly calibrated.

Use "Select Audiometer" from the home screen to search for the calibration file, it will typically be called ZZZ_YY.txt, where ZZZ is the serial number of the Osicus and YY is the year it was last calibrated. When found, select the file and press OK.

If the file cannot be located, you should contact the company that calibrated your Osicus for a copy of the latest calibration data and instructions on how to install it.

11. Factors which affect absolute accuracy

Measurement accuracy and repeatability will depend on the following:-

Calibration:	Please refer Technical Specification given on page
Temperature:	Use equipment in controlled conditions, please refer to Technical Specification given on page
External noise	Use equipment in an environment which limits external noise to the minimum. The basic headset provides very little attenuation of external noise. Audiocups fitted to the headset improves the situation, particularly for higher frequencies and a booth also improves attenuation but particularly for low frequencies. Refer to BS EN ISO 8253-1:2010 for details on acceptable test environments.
Headset positioning	Remove glasses, ear rings etc. Place the headset so it sits comfortably on the head, with the headband adjusted for best fit.
Patient cooperation:	Advise the patient to press and release the button as soon as they hear the tone. A familiarisation facility is available when using the "Single" test button.

12. Maintenance / Technical Information

The Osicus audiometer should have its calibration checked each day using a bio-simulator box (artificial ear) or by testing someone whose hearing levels are known, on at least 3 frequencies on each ear. In addition to this the cables should be inspected regularly for signs of damage, in particular in the region of the response button and where the cables approach the headset.

13. Calibration

Annual calibration should be performed by an approved supplier, who has access to the Osicus calibration software and whose equipment has been calibrated to traceable standards.

14. Cleaning

14.1 Instrument Enclosure



Unplug instrument from the PC and the USB cable supplied prior to cleaning.

Should the enclosure require cleaning for any reason, unplug it from the PC and wipe it with a damp cloth, or a cloth soaked in a mild alcohol based solution or cleaning wipes. Do not allow liquid to run into the enclosure.

14.2 Patient Contact Parts



Must be cleaned with a non-alcoholic wipe and care taken to prevent liquid build up.

The Earphone Cushions, Audiocup cushions and the Response Button must be cleaned with a non-alcoholic cleaning or disinfection wipe. Care should be taken to prevent the build-up of liquid on the earphone.

Note: The use of an alcohol based wipe has the effect of spreading, and therefore changing the profile of, the earphone cushions.

15. Supplied Parts

The following parts are supplied with the Instrument

Osicus Instrument
Response Button
Headset with Audiocup Sound Reduction Headset
USB link to PC
User Manual
Software USB stick
Calibration certificate

16. Spare Parts and Consumables

Additional consumables or spare parts can be ordered against the codes below

Item	Part No
Response Button Unit	RB
Earphone cable	AO-CS
Earphone Cushion (Pair)	E/CUS
Audiocup Cushion	A-CUS
Earphones (TDH39 / DD45)	EPS-39 / EPS-45
Audiocup Background Noise Reduction Headset	ACHS
Carry Case	AO-T

Appendix 1: Guidance on the Electromagnetic environment in which to operate the instrument.



Use of portable telephones or other radio frequency (RF) emitting equipment near the system may cause unexpected or adverse operation

The Osicus has been tested to EN60601-1-2:2015, regarding its ability to operate in an environment containing other electrical/electronic equipment (including other medical devices).

The purpose of this testing is to ensure that the Osicus is not likely to adversely affect the normal operation of other such equipment and that other such equipment is not likely to adversely affect the essential operation of the Osicus.

Despite the testing of the Osicus that has been undertaken, normal operation can be affected by other electrical/electronic equipment and portable and mobile RFcommunications equipment.

As the Osicus is medical equipment, special precautions are needed regarding EMC (electromagnetic compatibility).

It is important that the Osicus is configured and installed/put into service, in accordance with the instructions/guidance provided herein and is used only in the configuration as supplied.

Changes or modifications to the Osicus may result in increased emissions or decreased immunity of the instrument in relation to EMC performance.

The Osicus should be used only with the cables, accessories and transducers provided by GM Instruments. The cables should not be extended by the user. If the cable is extended by the user, this may result in an increased level of emissions or decreased level of immunity, in relation to the Osicus EMC. The use of the cables, accessories and transducers with devices other than the Osicus, may result in an increased level of emissions or decreased level of immunity, in relation to the other device's EMC.

The Osicus should not be used adjacent to or stacked with other equipment. If adjacent or stacked use with other equipment is necessary, the Osicus and the other equipment should be observed/monitored, to verify normal operation in the configuration in which it will be used.

For the purposes of EN60601-1-2 the Osicus has an essential performance (The instrument should not produce tones greater than 100dB unless permitted by the user).

Appendix 1: Guidance on the Electromagnetic environment in which to operate the instrument (cont)

Guidance and manufacturer's declaration – electromagnetic emissions		
The Osicus is intended for use in the electromagnetic environment specified below. The customer or the user of the Osicus should assure that it is used in such an environment.		
Emission test	Compliance	Electromagnetic environment - guidance
RF emissions CISPR 11	Group 1 Class B	The equipment is suitable for use in a professional healthcare facility environment only.
Harmonic emissions IEC61000-3-2	N/A	
Voltage fluctuations / flicker emissions IEC61000-3-3	N/A	

Guidance and manufacturer's declaration – electromagnetic immunity			
The Osicus is intended for use in the electromagnetic environment specified below. The customer or the user of the Osicus should assure that it is used in such an environment.			
Immunity test	IEC 60601 test level	Compliance level	Electromagnetic environment -
Electrostatic discharge (ESD) IEC61000-4-2	± 2, 4, 6, 8 kV contact ± 2, 4, 8, 15 kV air	± 2, 4, 6, 8 kV contact ± 2, 4, 8, 15 kV air	Floors should be wood, concrete or ceramic tile. If floors are covered with synthetic material, the relative humidity should be
Electrical fast transient / burst IEC61000-4-4	± 2 kV for power supply lines ± 1 kV for input / output lines	N/A	Mains power quality should be that of a typical commercial or hospital environment.
Surge IEC61000-4-5	± 1 kV line(s) to line(s) ± 2 kV line(s) to earth	N/A	Mains power quality should be that of a typical commercial or hospital environment.

Voltage dips, short interruptions and voltage variations on power supply input lines IEC61000-4-11	<5% U_T (>95 % dip in U_T) For 0.5 cycle 40% U_T (60 % dip in U_T) for 5 cycles 70 % U_T (30 % dip in U_T) for 25 cycles <5% U_T (>95 % dip in U_T) For 5 s	N/A	Mains power quality should be that of a typical commercial or hospital environment. If the user of the Osicus requires continued operation during power mains interruptions, it is recommended that the Osicus be powered from an uninterruptable power supply or a battery.
Power frequency (50/60Hz) Magnetic field IEC61000-4-8	30 A/m	30 A/m	Power frequency magnetic fields should be at levels characteristics of a typical location in a typical commercial or hospital
NOTE U_T is the a.c. mains voltage prior to application of the test level.			

Appendix 1: Guidance on the Electromagnetic environment in which to operate the instrument (cont)

Guidance and manufacturer's declaration – electromagnetic immunity			
The Osicus is intended for use in the electromagnetic environment specified below. The customer or the user of the Osicus should assure that it is used in such an environment.			
Immunity test	IEC 60601 test level	Compliance level	Electromagnetic environment - guidance
Conducted RF IEC61000-4-6	3 Vrms 150 kHz to 80 MHz	N/A	Portable and mobile RF communications equipment should be used no closer to any part of the Osicus, including any cables, than the recommended separation distance calculated from the equation applicable to the frequency of the transmitter. Recommended separation distance (d) $d = 1.2\sqrt{P}$
Radiated RF IEC61000-4-3	3 V/m 80 MHz to 2.7 GHz	3 V/m	$d = 1.2\sqrt{P}$ 80 MHz to 800 MHz $d = 2.3\sqrt{P}$ 800 MHz to 2.5 GHz Where P is the maximum output power rating of the transmitter in watts (W) according to the transmitter manufacturer and d is the recommended separation distance in metres (m).

Proximity fields from RF wireless communications IEC61000-4-3	Frequency - Test Level 385MHz - 27 V/m 450MHz - 28 V/m 710MHz - 9V/m 745MHz - 9V/m 780MHz - 9V/m 810MHz - 28 V/m 870MHz - 28 V/m 930MHz - 28 V/m 1.72GHz - 28 V/m 1.845GHz - 28 V/m 1.97GHz - 28 V/m 2.45 GHz - 28 V/m 5.24GHz - 9V/m 5.50GHz - 9V/m 5.875GHz - 9V/m	Frequency - Test Level 385MHz - 27 V/m 450MHz - 28 V/m 710MHz - 9V/m 745MHz - 9V/m 780MHz - 9V/m 810MHz - 28 V/m 870MHz - 28 V/m 930MHz - 28 V/m 1.72GHz - 28 V/m 1.845GHz - 28 V/m 1.97GHz - 28 V/m 2.45 GHz - 28 V/m 5.24GHz - 9V/m 5.50GHz - 9V/m 5.875GHz - 9V/m	Fields strengths from fixed RF transmitters, as determined by an electromagnetic site survey, ^a should be less than the compliance level in each frequency range. ^b Interference may occur in the vicinity of equipment marked with the following symbol: 
---	---	---	--

NOTE 1 At 80 MHz and 800 MHz, the higher frequency range applies.

NOTE 2 These guidelines may not apply in all situations. Electromagnetic propagation is affected by absorption and reflection from structures, objects and people.

^a Field strengths from fixed transmitters, such as base stations for radio (cellular/cordless) telephones and land mobile radios, amateur radio, AM and FM radio broadcast and TV broadcast cannot be predicted theoretically with accuracy. To assess the electromagnetic environment due to fixed RF transmitters, an electromagnetic site survey should be considered. If the measured field strength in the location in which the Osicus is used exceeds the applicable RF compliance level above, the Osicus should be observed to verify normal operation. If abnormal performance is observed, additional measures may be necessary, such as re-orientating or relocating the Osicus

^b Over the frequency range 150 kHz to 80 MHz, field strengths should be less than 3 V/m.

Appendix 2: Technical Information (relative to EN 60601-1:2006+A12:2014)



No modification to this equipment is allowed.

6.2 The Osicus Audiometer is powered from a laptop or PC via the supplied USB cable. Power can be removed by unplugging the USB cable from either the PC/laptop or the back of the Osicus.

It complies with the specification for Class 1 ME equipment, and can be used along with a PC and printer, normally supplied by the customer. NB the warning made earlier about the PC and printer being compliant with EN 60950 and placing these items out of the reach of a subject.

The Applied Parts comprise, Right and Left Headset and the Response Button, which are classified as type B applied part.

The Applied Parts (headphones and response switch) are the only parts used in the patient environment.

The laptop/PC are used in the non-patient environment.

6.3 The enclosure does not provide protection against the ingress of liquids and is therefore classified as IPX0.

6.4 There are no parts which are supplied sterile or are required to be sterile.

6.5 The Osicus Audiometer is **NOT** suitable for use in an oxygen rich environment.

6.6 The Osicus Audiometer is rated for continuous use.

7.2.2 The Osicus serial number can be found on the label on the back panel, and the software version number can be viewed on the start-up screen and by clicking on Help, found on the top bar of the software (when fitted)

7.2.3 Information is given in the Warning and Caution section of this manual, which the user must read prior to operating this instrument. Appropriate labels are fixed to the back panel

7.2.4 The Headset and Response Button are identified as accessories with part numbers

7.2.5 The Osicus power is intended to receive power via a USB connection with a ISO 60950 compliant laptop/PC. The USB connection is marked with ISO 7010-M002 safety sign.

7.2.6 The USB provides the Osicus with DC voltages of 5 volts dc.

7.2.11 The Osicus Audiometer is rated for continuous use.

7.2.17 Environmental conditions for transport and storage with no additional special measures
Temperature: -40 °C to +60 °C

Humidity: 30 to 90% RH
Pressure 98 kPa to 104 kPa

7.9.1 The Osicus Audiometer can be used by any medically trained technician, nurse or doctor, who has either read this manual or who has been trained by a competent authority in its use.

7.9.2.1 The Osicus Audiometer health care professional or competent person in medical environment, i.e. hospital, clinic.

7.9.2.3 The Osicus power is intended to receive power via a USB connection with a ISO 60950 compliant laptop/PC. The combination is considered to be an ME SYSTEM.

7.9.2.5 The Headset and Response Button are considered to be the applied parts.

7.9.2.7 The equipment should be positioned to enable it to be disconnected from the PC or laptop quickly and easily.

7.9.2.10 Error Messages --- see Troubleshooting section in section

7.9.2.11 The Osicus software can be closed by clicking EXIT. The Osicus hardware can be switched off by either of the following:

Removing the USB cable from the back of the Osicus

By disconnecting it from the PC USB socket

Powering down the PC

7.9.2.13 There are no parts which need routine maintenance or servicing other than general "housekeeping", such as keeping the equipment clean and cables free of twisting

7.9.2.15 The EXPECTED SERVICE LIFE of the Osicus has been evaluated and determined to be 10 years from the date of manufacture. After this time, the Osicus and the accessories, Headset and Response Button can be returned to GM Instruments for dismantling and disposal, while your PC/Printer should be returned to your supplier for dismantling and disposal.

These parts are subject to the WEEE directive, and should not be disposed of in landfill.

7.9.3.2 The only parts which are interchangeable by service personnel are the power module and the mains cable. If these are changed, a Medical Electrical Safety test to the current standard should be made prior to allowing release for use.

7.9.3.3 Circuit diagrams, component lists and parts lists are available on request, along with email/telephone advice to service personnel trained and qualified to work on ME devices. Modification of the Osicus Audiometer is not allowed.

7.9.3.4 If access to the Osicus circuit board is required:-

Disconnect the Osicus by disconnecting the USB cable linking it to the computer

Turn the unit over and remove the 4 feet on the base.

Turn the unit back over and remove the top panel.

The circuit board can now be accessed and if voltage measurements are required, the mains power or USB link can be reconnected.

16.2 The headphones and hand-switch (Applied Parts) are the only parts used in the patient environment and the laptop / desktop PC are used in the non-patient environment

Connect only items that have been specified as part of, or specified as being compatible with the Osicus Audiometer. Supplied and compatible spare parts and accessories are listed in Section 15 & 16 of this manual.

Assembly of ME SYSTEMS and modifications during actual service life shall be evaluated based on the requirements of this standard, BS EN 60601-1:2006+A1:2013.